

VALE – PENDANT

CAINE HEINTZMAN / 2019

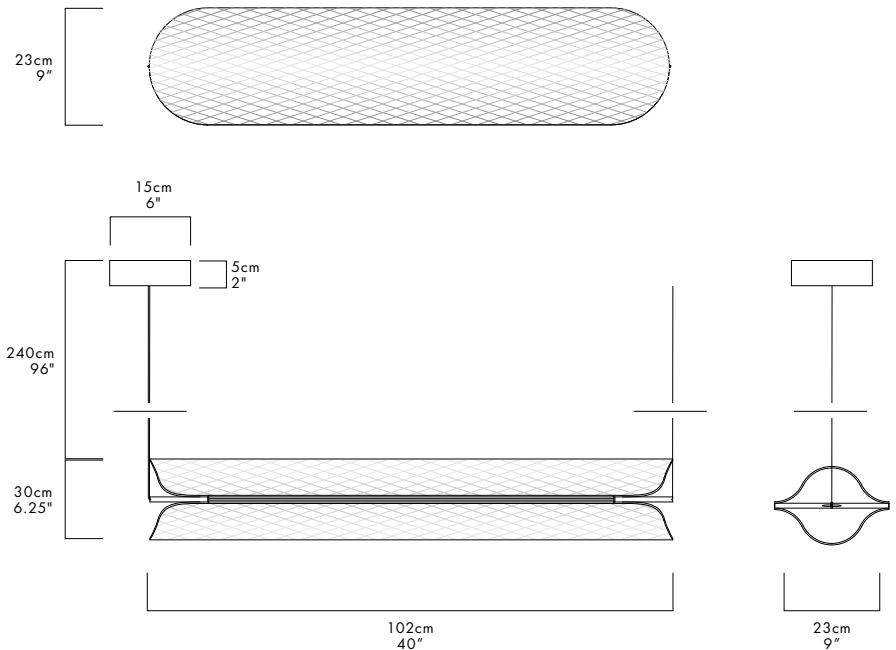

VAL-1-P-CLR-ANT-27-MLV-120



DESCRIPTION

The Vale series optimises functionality through its multidirectional luminescence while diffusing soft ambient light.

MATERIALS

- Acrylic
- Aluminum

MANUFACTURED

Canada

DIMENSIONS

102 x 30 x 23 cm / 40" x 6.25" x 9"

ELECTRICAL

- 20W LED
- 50,000 hour Lifetime
- 90+ CRI
- Input Voltage 100–240V + 277V
- Integral 24V DC power supply included
- Dimming Options: MLV, 0–10, Dali

COLOUR TEMPERATURE OPTIONS

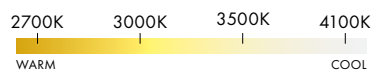

CERTIFICATIONS



FRAME FINISHES



LENS FINISH



SERIES	QTY	TYPE	LENS	FINISH	CCT	PS	VOLTAGE IN
VAL	<input type="checkbox"/> 1	P	CLR (CLEAR)	<input type="checkbox"/> ANT (ANTHRACITE)	<input type="checkbox"/> 27 (2700K)	<input type="checkbox"/> MLV*	<input type="checkbox"/> 120
	<input type="checkbox"/> 2			<input type="checkbox"/> SIL (SILICA)	<input type="checkbox"/> 30 (3000K)	<input type="checkbox"/> 010	<input type="checkbox"/> 230
	<input type="checkbox"/> 3			<input type="checkbox"/> RST (RUST)	<input type="checkbox"/> 35 (3500K)	<input type="checkbox"/> DAL	<input type="checkbox"/> 277
				<input type="checkbox"/> 41 (4100K)			

*STANDARD STOCK FOR 120V

MODIFIED: 10/29/19



WWW.ANDLIGHT.CA
INFO@ANDLIGHT.CA
+1 604 563 6938

505 B RAILWAY STREET
VANCOUVER, BC
CANADA V6A 1A7

The Vale suspends horizontally or vertically, as a single or multiple pendant. Its edge-to-edge or end-to-end connection allows for a variety of arrangements.

The following diagrams illustrate several examples of Vale's flexibility.

HORIZONTAL, EXAMPLE, EDGE-TO-EDGE

VAL-1-P

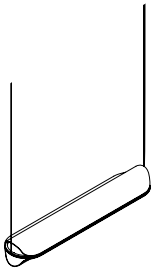

VAL-2-P

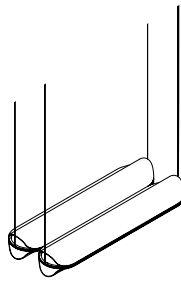

VAL-3-P

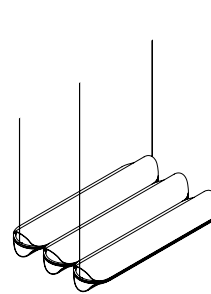

HORIZONTAL, EXAMPLE, END-TO-END

VAL-1-P

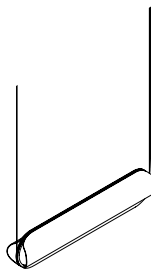

VAL-2-P

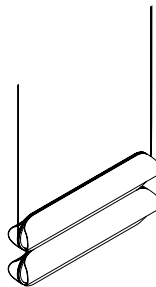

VAL-3-P

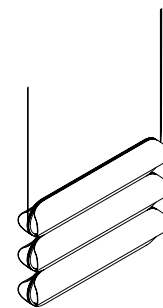

HORIZONTAL, EXAMPLE, END-TO-END

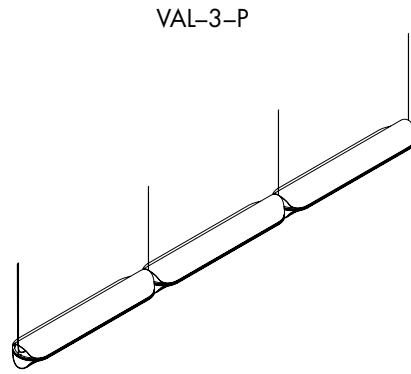
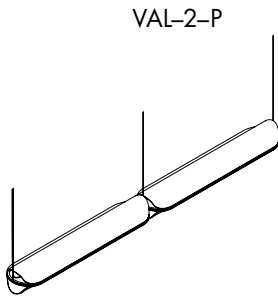

HORIZONTAL, EXAMPLE, END-TO-END

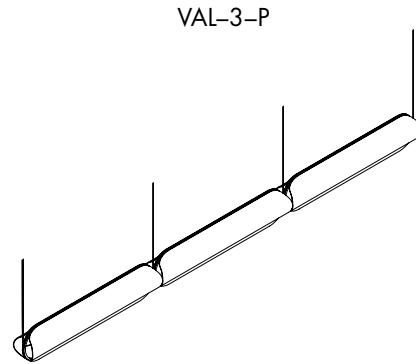
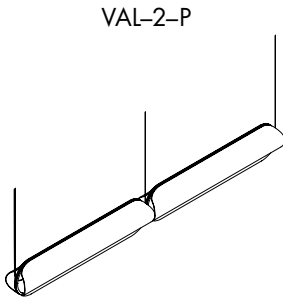

VERTICAL, EXAMPLE, END-TO-END

