

groove

prodotto

caccaro

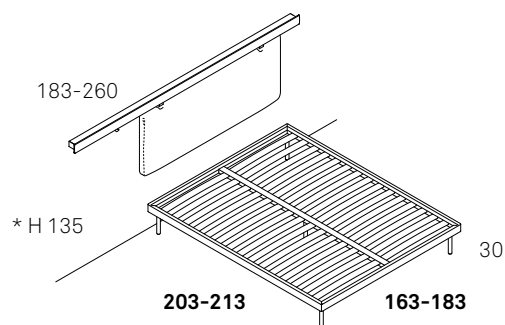
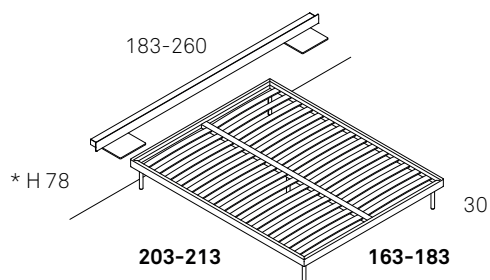
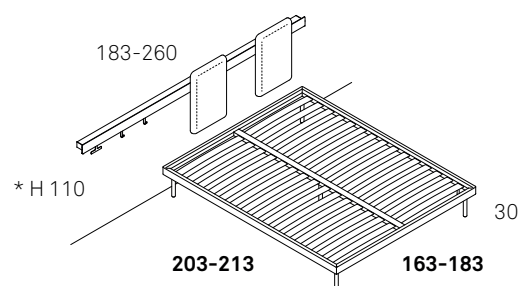

groove

finiture

laccato opaco

caccaro

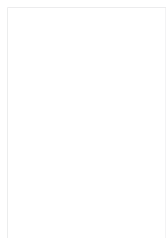

* bianconeve

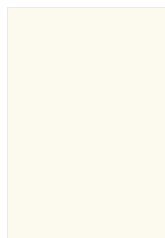

bianco 9010



nero stout



* rugiada



fumo



grafite

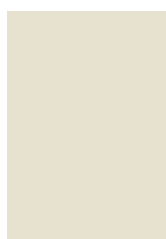

* gesso



* polvere



ombra

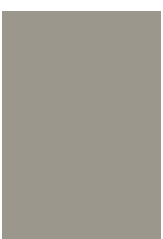

sabbia

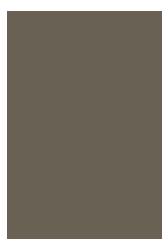

tundra



pece

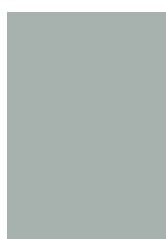

cielo



ardesia



indaco

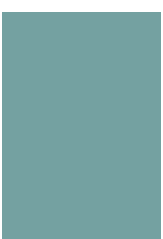

salvia



finiture all'acqua

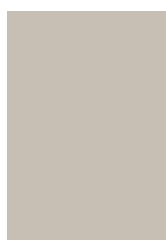

cenere



terra

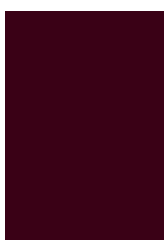

borgogna

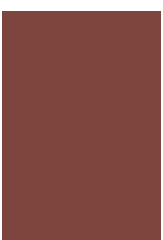

cotto



amarone

colore campione
per tutte le finiture con
opacità di serie



sahara

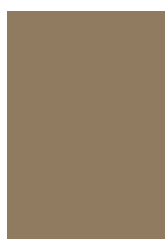

savana



mattone

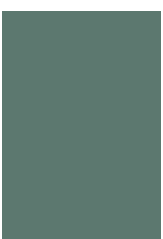

quarzo



scoglio



ral / ncs

letti / groove

Per specifiche contatta il rivenditore

groove

caccaro

tessuti

SCOTT



01



02



04



03

COMPOSIZIONE 56% CO - 30% VI - 14% LI



STEP



01



02



04



05



03

COMPOSIZIONE 58% CO - 27% VI - 15% LI



PLAIN



01



02

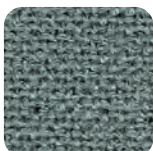

03



04

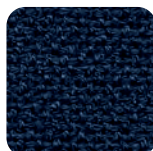

05



06

COMPOSIZIONE 54% CO - 30% VI - 16% LI



FELT



01

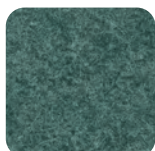

02



03



04



05



07

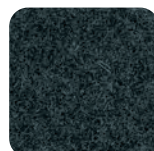

06

COMPOSIZIONE 70% WO - 25% PA - 5% AF

