

# NEW YORK

design: Peter Jamieson / 2013

# KUNDALINI

Lampada a sospensione con riflettore in tecnopolimero multistrato e diffusore in metacrilato prismatico.

*Suspension lamp with multilayered technopolymer reflector and prismatic methacrylate diffuser.*



## CERTIFICAZIONI - CERTIFICATIONS



Apparecchio di classe I  
Product in class I

IP20

Apparecchio per uso interno  
Product for indoor use



Apparecchio conforme alla direttiva europea 2006/95/EC  
Product in conformity with the European directive 2006/95/EC



Apparecchio di illuminazione da smaltire secondo la direttiva EU 2002/96/EC  
This lamp must be disposed in conformity with the EU directive 2002/96/EC

## DIMENSIONI - DIMENSIONS

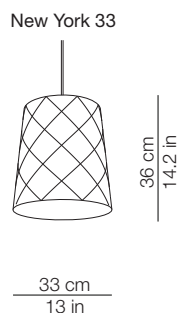

## IMBALLO - PACKAGING

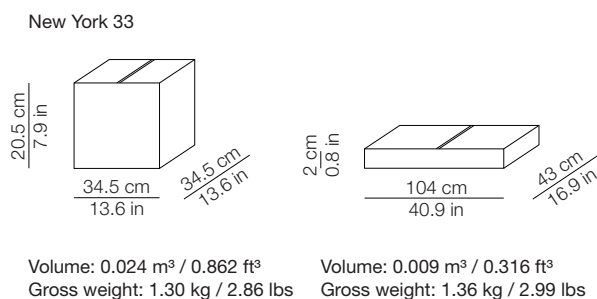

## DIMENSIONI - DIMENSIONS

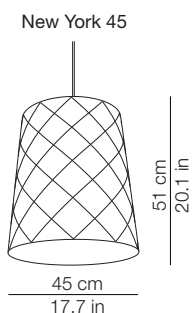

## IMBALLO - PACKAGING

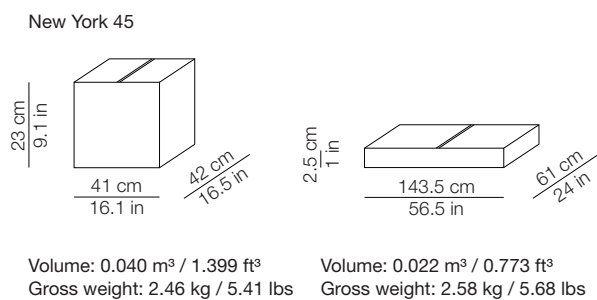

## MATERIALI E FINITURE - MATERIALS AND FINISHINGS

riflettore  
reflector

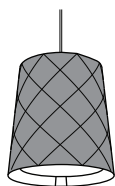

bianco - white



grigio cromo - grey chrome



rosso - red

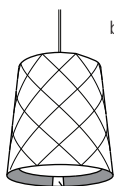

bianco - white



banda rossa  
- red strip



texture

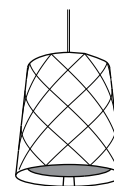

diffusore  
diffuser

tecnopolimero multistrato  
multilayered technopolymer

metacrilato prismatico  
prismatic methacrylate

INFORMAZIONI AGGIUNTIVE - FURTHER INFORMATION

230V  
or  
120V

Alimentazione  
*Feeding*



Lampadine - *Bulbs*

NEW YORK 33

1 x max30W E27 (E26 US) - Fluorescent  
or 1 x 16W E27 (E26 US) - Led

NEW YORK 45

3 x max30W E27 (E26 US) - Fluorescent  
or 3 x 16W E27 (E26 US) - Led



*Energy efficiency class from A+ to E*

Lampada a sospensione  
*Suspension lamp*



Rosone - diam. ca. 12.5cm h. 3cm - bianco  
fissato a soffitto con tasselli (2-4) non forniti

*Canopy - diam. about 4.9in h. 1.2in - white  
fixed to the ceiling with not provided screws (2-4)*



Cavo di alimentazione trasparente - lunghezza 180cm  
altre lunghezze su richiesta

*Transparent cord set - length 70.8in  
different lengths on request*

