

JONAH TAKAGI

# MEWOMA 120

Table ●● 2015



## MATERIALS & FINISHES

### FINISHES

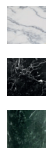

- White Pele de tigre marble
- Black Marquina marble
- Indian green marble

### MATERIALS

- Metal base
- Light oak veneer
- Marble

## DIMENSIONS & WEIGHT

	MEWOMA	WITH PACKAGING
HEIGHT	74cm / 29,2 in.	130x100x145cm / 51,2x39,4x57,2in.
DIAMETER	120cm / 47,3in.	95x95x80cm / 37,4x37,4x31,5in.  90x90x5cm / 35,5x35,5x2in.
WEIGHT	90kg / 199lbs.	125kg / 275lbs.

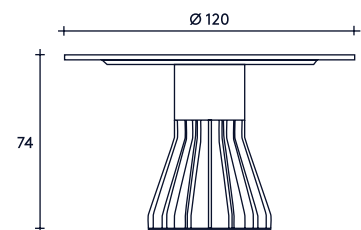

## OTHER DETAILS

TECHNICAL INFORMATION	Delivery: 6 weeks Needs assembly Marble is a natural product. Shade and pattern may vary between two tables.
PACKAGING	2 thick cardboard boxes and 1 wooden crate
MAINTENANCE	Always use a microfiber cloth and rub lightly. Never apply any solvents.

JONAH TAKAGI



# MEWOMA 150

Table ●● 2015



## MATERIALS & FINISHES

### FINISHES

-  White Pele de tigre marble
-  Black Marquina marble
-  Indian green marble

### MATERIALS

- Metal base
- Light oak veneer
- Marble

## DIMENSIONS & WEIGHT

	MEWOMA	WITH PACKAGING
HEIGHT	74cm / 29,2in.	160x100x180cm / 63x39,4x70,9in.
DIAMETER	150cm / 59,1in.	95x95x80cm / 37,4x37,4x31,5in.  90x90x5cm / 35,5x35,5x2in.
WEIGHT	110kg / 243lbs.	125kg / 275lbs.

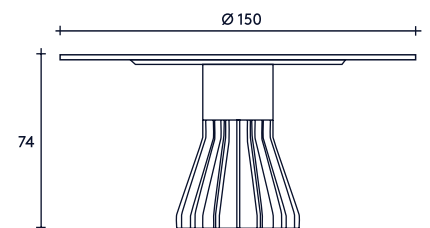

## OTHER DETAILS

TECHNICAL INFORMATION	Delivery: 6 weeks Needs assembly Marble is a natural product. Shade and pattern may vary between two tables.
PACKAGING	2 thick cardboard boxes and 1 wooden crate
MAINTENANCE	Always use a microfiber cloth and rub lightly. Never apply any solvents.

JONAH TAKAGI

# MEWOMA DOUBLE

Table ●● 2017



## MATERIALS & FINISHES

- FINISHES**
- Dark blue stained solid ash
  - B Choose you essence of wood

## MATERIALS

- Metal base
- Ash solid wood

## DIMENSIONS & WEIGHT

	MEWOMA	WITH PACKAGING
HEIGHT	74cm / 29,2in.	310x130x30cm / 122x51,2x11,9in.
WIDTH	260 or 300cm / 102,4 or 118,2in.	95x95x80cm / 37,4x37,4x31,5in.
DEPTH	110cm / 43,4in.	90x90x5cm / 35,5x35,5x2in.
WEIGHT	150kg / 330lbs.	190kg / 418lbs.

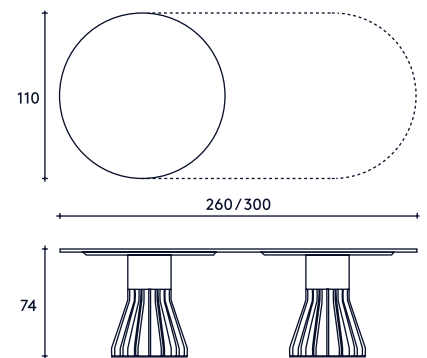

## OTHER DETAILS

TECHNICAL INFORMATION	Delivery: 6 weeks Needs assembly
PACKAGING	2 thick cardboard boxes and 1 wooden crate
MAINTENANCE	Always use a microfiber cloth and rub lightly. Never apply any solvents.