

REVISED 9/12/18

PRODUCT

JOULLE CHANDELIER
 JOULLE 04-001

MATERIALS (FINISHES)

ANODIZED ALUMINUM (AGED
 BRONZE, GOLDEN BRONZE, BLACK,
 SILVER)

SOLID OPTIC CRYSTAL (CLEAR,
 FROSTED, SMOKE)

WEIGHT

3.5 LBS

LAMPING

INTEGRATED LED (QTY 4)
 13W, 3000K
 ELV AND PHASE DIMMABLE

CERTIFICATIONS

ETL LISTED (120V) - PENDING

NOTES

JOULLE IS COMPRISED OF
 MODULAR COMPONENTS AND IS
 MEANT TO BE ASSEMBLED
 ON-SITE BY A QUALIFIED
 ELECTRICIAN AND INSTALLATION
 PROFESSIONAL.



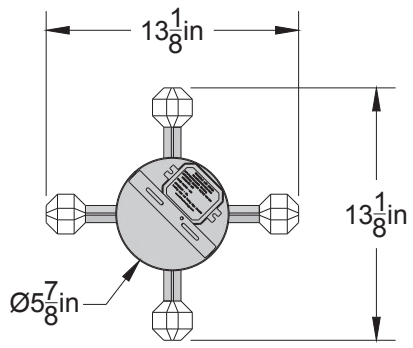

TOP VIEW

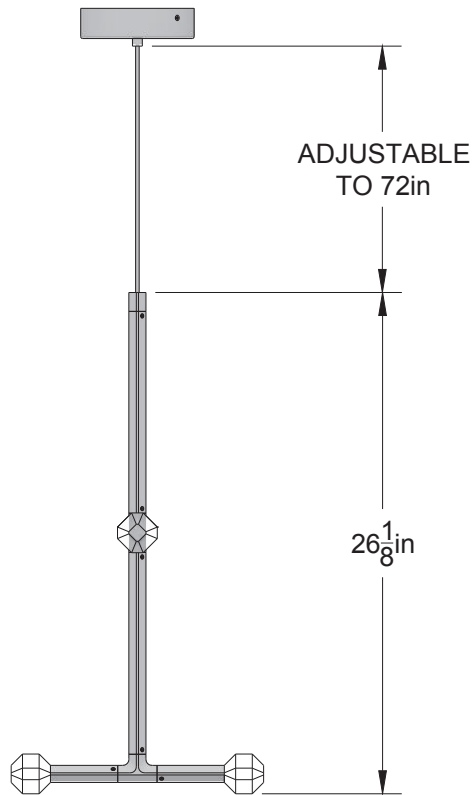

FRONT VIEW

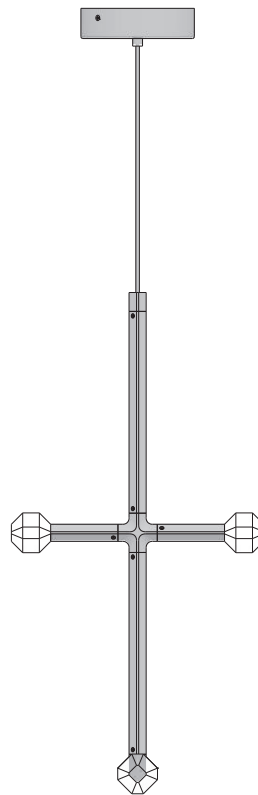

SIDE VIEW

© 2018, LAKE AND WELLS, LLC ALL RIGHTS RESERVED