

REVISED 9/12/18

PRODUCT

JOULLE CHANDELIER
JOULLE 26-001

MATERIALS (FINISHES)

ANODIZED ALUMINUM (AGED
BRONZE, GOLDEN BRONZE, BLACK,
SILVER)

SOLID OPTIC CRYSTAL (CLEAR,
FROSTED, SMOKE)

WEIGHT

19.1 LBS

LAMPING

INTEGRATED LED (QTY 26)
13W, 3000K
ELV AND PHASE DIMMABLE

CERTIFICATIONS

ETL LISTED (120V) - PENDING

NOTES

JOULLE IS COMPRISED OF
MODULAR COMPONENTS AND IS
MEANT TO BE ASSEMBLED
ON-SITE BY A QUALIFIED
ELECTRICIAN AND INSTALLATION
PROFESSIONAL.



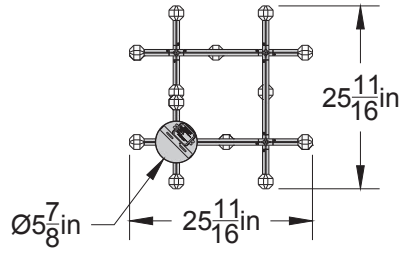

TOP VIEW

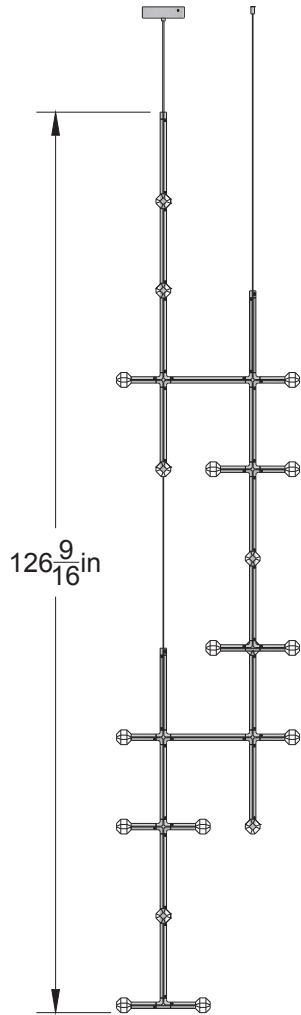

FRONT VIEW

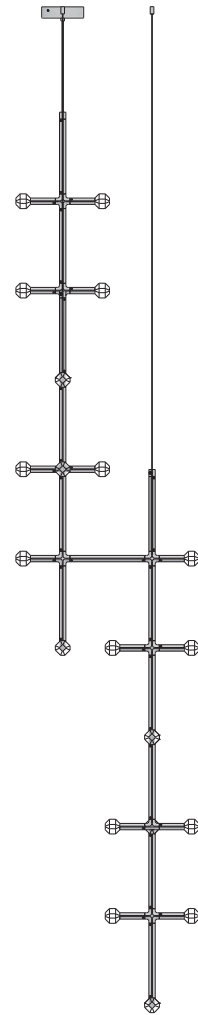

SIDE VIEW

© 2018, LAKE AND WELLS, LLC ALL RIGHTS RESERVED