

LITERATURA SELECTION ^{NEW}

Vicent Martínez. 2020

ENGLISH

FINISHES

Frame and shelf

White (RAL9016), Black (RAL9005), black nickel i, Bronze or gold Epoxi.

Front unit on wheels, shelf & base panel and storage unit***A:**

Oak.

Open pore white lacquered oak.

B:

Walnut.

C:

Stained oak: Ebony, Dark grey.

Whitened oak.

D:

Dark stained walnut .

* If the finish of the elements with wheels is different from the finish of the top and the base, see the highest price.

Crosspieces

Texturized lacquer: White, Black, Sand, Mustard, Cream, Rose, Bronze or Anthracite.

Metallic lacquer: rose, bronze, cooper and gold.

Wheels

The wheels are the same colour as the metallic structure.

La Literatura celebrates its 35th anniversary with another very special version. Noble, exquisite materials like wood and metal make it more selected, elegant, exquisite and subtle

MATERIALS

- Oak or walnut veneered MDF E1 (low formaldehyde content)
- Powder coated steel frame (16x16 mm.) and shelves (16x16 mm.)
- Polyamide wheels highly

Stability

Bookcase must be attached to the wall to ensure optimum stability

If used as partition, it is compulsory to place at least one storage module in each bay with the heaviest items on the lowest shelves

ESPAÑOL

ACABADOS

Estructura y estantes

Blanco (RAL9016), Negro (RAL9005) o Beige ^{NEW} (RAL1019).

Elementos con ruedas, base, tapa, estante y módulos contenedores***A:**

Roble

Roble lacado a poro abierto blanco.

B:

Nogal

C:

Roble teñido: Ébano, Gris oscuro.

Roble blanqueado.

D:

Nogal teñido oscuro .

* Para acabados de elementos con ruedas y tapa y base diferentes siempre el precio superior.

Crucetas

Lacado texturizado: Blanco, Negro, Arena, Mostaza, Crema, Rose, Bronze o Anthracite.

Lacado metalizado: rose, bronze, cobre y oro.

Ruedas

Ruedas del color de la estructura metálica.

Cuando la magia de un diseño es una idea esencial, tras pasa el tiempo y es capaz de continuar sorprendiéndonos.

Después de cumplir 35 años, la estantería Literatura lo celebra apareciendo con otra versión muy especial.

Materiales nobles y exquisitos como la madera y los metales la transforman para ser percibida como más selecta, más elegante, más exquisita, refinada y sutil.

MATERIALES

- MDF E1 (bajo contenido en formaldehído) aplacado en madera de roble o nogal natural.
- Estructura (16x16 mm) y estantes (16x16 mm) de acero termo-lacado.
- Ruedas en poliamida de alta resistencia a abrasión y a agentes químicos.
- Pies regulables.

Estabilidad

Las composiciones de estantería deben fijarse a pared para lograr una estabilidad óptima.

Si se desea utilizar como divisoria es imprescindible utilizar un módulo contenedor por columna de estantes y depositar los objetos más pesados en las partes bajas.

FRANCAIS

FINITIONS

Structure et étagères

Blanc (RAL9016), Noir (RAL9005), Epoxi noir nickel, epoxy bronze et gold epoxy.

Éléments avec roulettes, bases, couvercles et modules conteneurs***A:**

Chêne super mat.

Blanc chêne laqué à pores ouverts.

B:

Noyer super mat.

C:

Chêne teinté: Ébène, Gris foncé.

Chêne blanchi.

D:

Noyer teinté obscure .

* Pour les finitions d'éléments avec des roues différentes des finitions du plateau et de la base, prendre comme référence le prix de la gamme supérieure..

Croisillons

Laques texturées: Blanc, Noir, Sable, Moutarde, Crème, Rose, Bronze ou Anthracite.

Laqué métallique: rose, bronze, cooper et gold.

Roues

Roues de la couleur de la structure métallique.

Lorsque la magie d'un design porte une idée essentielle, elle traverse le temps et continue de nous surprendre. L'étagère Literatura célèbre ses 35 ans en apparaissant dans une nouvelle version très spéciale. Des matériaux nobles et exquis, tels que le bois et les métaux, lui donnent un aspect plus sélectif, plus élégant, plus exquis, raffiné et subtil.

MATERIAUX

- MDF E1 (faible teneur en formaldéhyde) plaqué en chêne ou en noyer naturel.
- Structure (16x16 mm) et étagères (16x16 mm) en acier thermolaqué.
- Roues en polyamide à haute résistance à l'abrasion et aux agents chimiques.
- pieds réglables.

Stabilité

Les composants de l'étagère doivent être fixés au mur pour une stabilité optimale.

Si l'on souhaite l'utiliser comme meuble de séparation il est indispensable d'utiliser un module de rangement par colonne d'étagère et de ranger les objets les plus lourds en partie basse.

DEUTSCH

AUSFÜHRUNGEN

Weiß (RAL9016), Schwarz (RAL9005), Schwarz Nickel Pulverbeschichtet ,Bronze Pulverbeschichtet und gold epoxi.

Elemente mit Rollen, Unter- und Oberplatten und Lagerungsmodule*

A:

Eiche
Eiche weiss offenporig lackiert.

B:

Walnuss

C:

Eiche gebeizt: Ebenholz, Dunkelgrau .
Eiche weiß.

D:

Walnuss dunkel gebeizt .

* Bei unterschiedlichen Ausführungen für Elemente mit Rollen und für die Platte gilt immer der höhere Preis..

Regaleinsatz Kreuz

Lackiert texturiert: Weiß, Schwarz, Sand, Senffarben, Cremefarben , Rose , Bronze oder Anthrazit .

Lackiert in Metal Farben: Rose, Kupfer, Bronze und gold

Rollen

Rollen sind farblich mit dem Rest der Struktur abgestimmt.

Wenn die Magie eines Designs eine wesentliche Idee ist, geht sie über die Zeit hinaus und ist in der Lage, uns immer wieder zu überraschen.

Nach seinem 35. Geburtstag feiert das Literatura-Regal ihn mit einer weiteren ganz besonderen Version.

Edle und exquisite Materialien wie Holz und Metalle verwandeln es in ein exklusiveres, eleganteres, exquisiteres, raffinierteres und subtileres Regal.

MATERIALIEN

- E1 MDF (niedriger Formaldehydgehalt), verkleidet mit Eiche oder Naturnuss.
- Struktur (16x16 mm) und Regale (16x16 mm) aus thermolackiertem Stahl.
- Räder aus Polyamid mit hoher Beständigkeit gegen Abrieb und chemische Einflüsse.
- Verstellbare Füße.

Stabilität

Jede Komposition der Regale sollte an Wänden befestigt werden, um eine optimale Stabilität zu erreichen.

Wenn man das Möbelstück als Raumtrennung nutzen möchte, sollte man unbedingt ein Lagermodul für jede Regal Säule einsetzen und die schweren Gegenstände in dem unteren Teil belassen.

ITALIANO

FINITURE

Struttura e ripiani

Bianco (RAL9016), Nero (RAL9005), Epossidico nero nichel ,epossidico bronzo e gold epoxi.

Elementi con rotelle, base e coperchi e moduli di archiviazione*

A:

Rovere
Rovere laccato a poro aperto Bianco.

B:

Noce

C:

Rovere tinto: Ebano, Grigio scuro
Rovere sbiancato.

D:

Noce tinto scuro .

* Per finiture di elementi con ruote con finiture diverse dal coperchio e la base sempre prezzo superiore.

Incrociate

Laccati testurizzati: Bianco, Nero, Sabbia, Senape, Crema , Rose , Bronze o Antracite .
Laccato metallico: rose, bronze, cooper e gold.

Rotelle

Rotelle del colore della struttura metallica.

Quando la magia di un disegno é un'idea essenziale, traspassa il tempo ed é capace di continuare a sorprenderci. Dopo aver compiuto 35 anni, la libreria Literatura si celebra o con un'altra versione molto speciale.

Materiali nobili e squisiti come il legno e i materiali la trasformano per essere percepita in modo piú esclusivo, piú elegante, piú squisita, raffinata e sobria.

MATERIALI

- MDF (basso contenuto di formaldeide) impiallacciato in legno di rovere o noce naturale.
- Struttura (16x16mm) e scaffali (16x16mm) di acciaio termolaccato.
- Ruote di poliammide di alta resistenza all'abrasione e ad agenti chimici.
- piedi regolabili

Stabilità

Le composizioni di librerie devono fissarsi a parete per ottenere un'ottima stabilità.

Se si desiderano utilizzare come divisori é necessario usare un modulo contenitore per colonna di scaffali e depositare gli oggetti piú pesanti nelle parti basse.

METAL FRAME :

- Gold epoxi
- Bronze epoxi
- Black nickel
- Black
- White

Natural oak or walnut wood veneer.

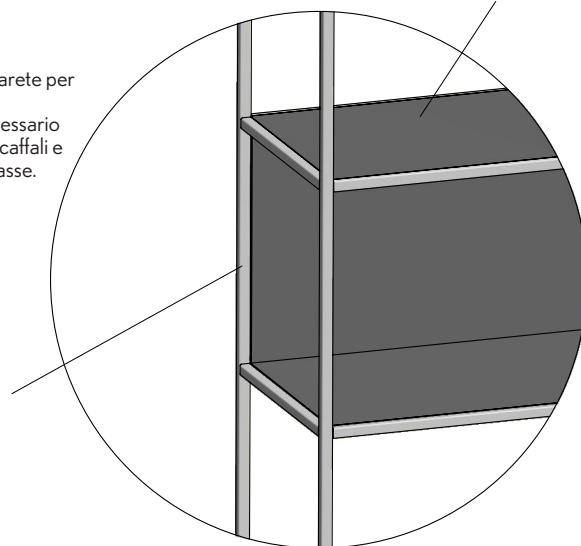

LENGTH DEPTH HEIGHT REFERENCE

WOODEN SHELF WITH METAL FRAME

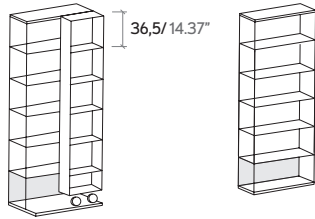

LPS510

LSS510

90,3	57	225,6 cm	LPS510
35,55"	22,44"	88,82"	
90,3	35,5	225,6 cm	LSS510*
35,55"	13,98"	88,82"	

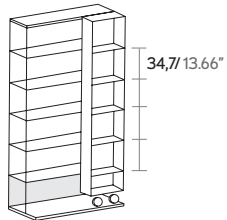

120,3	57	225,6 cm	LPS501
47,36"	22,44"	88,82"	
120,3	35,5	225,6 cm	LSS501*
47,36"	13,98"	88,82"	

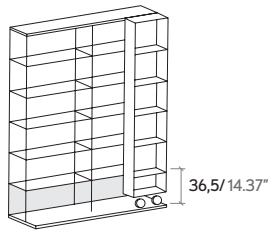

179	57	225,6 cm	LPS520
70,47"	22,44"	88,82"	
179	35,5	225,6 cm	LSS520*
70,47"	13,98"	88,82"	

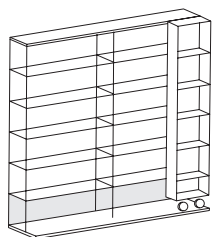

239	57	225,6 cm	LPS502
94,09"	22,44"	88,82"	
239	35,5	225,6 cm	LSS502*
94,09"	13,98"	88,82"	

* Estantería de fondo total 35,5 sin carro sobre ruedas / 35,5-centimeter depth bookcase without trolley on casters / Étagère de profondeur totale de 35,5cm sans le chariot sur roues / Libreria con profondità 35,5 senza carrello su ruote / Total Tiefe des Regals : 35.5 ohne Wagen mit Rollen

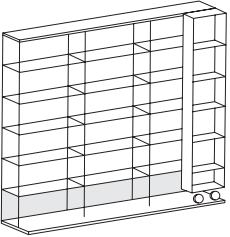
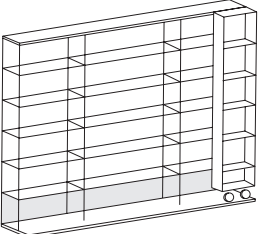
	LENGTH	DEPTH	HEIGHT	REFERENCE
	267,7	57	225,6 cm	LPS530
	105,39"	22,44"	88,82"	
	267,7	35,5	225,6 cm	LSS530*
	105,39"	13,98"	88,82"	
	297,7	57	225,6 cm	LPS521
	117,2 "	22,44"	88,82"	
	297,7	35,5	225,6 cm	LSS521*
	117,2 "	13,98"	88,82"	

MÓDULO TELEVISIÓN/ TV MODULE

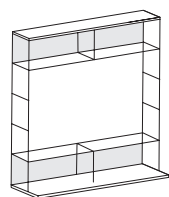

179	57	225,6 cm	LPS522
70,47"	22,44"	88,82"	

ELEMENTS ON WHEELS/ MÓDULOS CON RUEDAS/ MODULES AVEC ROULETTES/ MODULE MIT ROLLEN/ MODULI CON ROTELLE

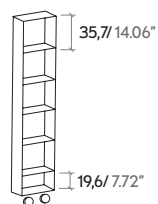

45	21	222 cm	LOM500
17,72"	8,27"	87,24"	

* Estantería de fondo total 35,5 sin carro sobre ruedas / 35,5-centimeter depth bookcase without trolley on casters / Étagère de profondeur totale de 35,5cm sans le chariot sur roues / Libreria con profondità 35,5 senza carrello su ruote / Total Tiefe des Regals : 35.5 ohne Wagen mit Rollen

NOTE: See containing units at page 45/ Ver módulos contenedores en pag.45/ Voir modules de rangement page 45/ Lagerungsmodule auf der Seite 45/ Vedi moduli contenitori a pagina 45.

	LENGTH	DEPTH	HEIGHT	REFERENCE
--	--------	-------	--------	-----------

WOODEN SHELF WITH METAL FRAME

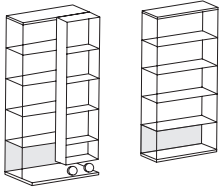

LOP410 LOS410

90,3	57	189,5 cm	LPS410
35,55"	22,44"	74,61"	
90,3	35,5	189,5 cm	LSS410*
35,55"	13,98"	74,61"	

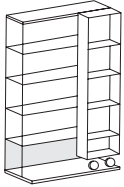

120,3	57	189,5 cm	LPS401
47,36"	22,44"	74,61"	
120,3	35,5	189,5 cm	LSS401*
47,36"	13,98"	74,61"	

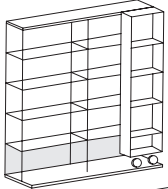

179	57	189,5 cm	LPS420
70,47"	22,44"	74,61"	
179	35,5	189,5 cm	LSS420*
70,47"	13,98"	74,61"	

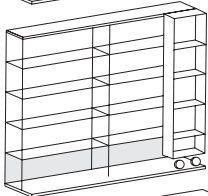

239	57	189,5 cm	LPS402
94,09"	22,44"	74,61"	
239	35,5	189,5 cm	LSS402*
94,09"	13,98"	74,61"	

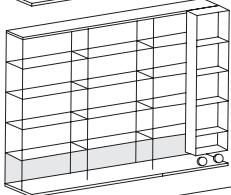

267,7	57	189,5 cm	LPS430
105,39"	22,44"	74,61"	
267,7	35,5	189,5 cm	LSS430*
105,39"	13,98"	74,61"	

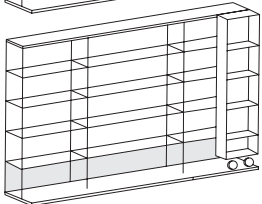

297,7	57	189,5 cm	LPS421
117,2"	22,44"	74,61"	
297	35,5	189,5 cm	LSS421*
116,93"	13,98"	74,61"	

MÓDULO TELEVISIÓN/ TV MODULE

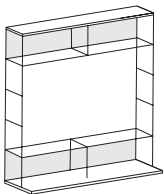

179	57	189,5 cm	LPS422
70,47"	22,44"	74,61"	

* Estantería de fondo total 35,5 sin carro sobre ruedas / 35,5-centimeter depth bookcase without trolley on casters / Étagère de profondeur totale de 35,5cm sans le chariot sur roues / Libreria con profondità 35,5 senza carrello su ruote / Total Tiefe des Regals : 35.5 ohne Wagen mit Rollen

ELEMENTS ON WHEELS/ MÓDULOS CON RUEDAS/ MODULES AVEC ROULETTES/ MODULE MIT ROLLEN/ MODULI CON ROTELLE

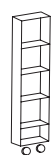

LENGTH	DEPTH	HEIGHT	REFERENCE
45	21	186 cm	LOM400
17,72"	8,27"	73,23"	

WOODEN SHELF WITH METAL FRAME



90,3	57	117 cm	LPS210
35,55"	22,44"	46,06"	



90,3	35,5	117 cm	LSS210*
35,55"	13,98"	46,06"	

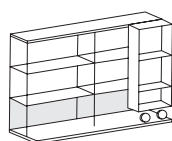

120,3	57	117 cm	LPS201
47,36"	22,44"	46,06"	

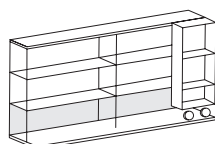

120,3	35,5	117 cm	LSS201*
47,36"	13,98"	46,06"	

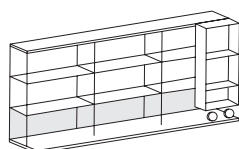

179	57	117 cm	LPS220
70,47"	22,44"	46,06"	

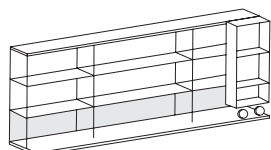

179	35,5	117 cm	LSS220*
70,47"	13,98"	46,06"	

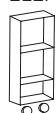

45	21	112 cm	LOM200
17,72"	8,27"	44,17"	

ELEMENTS ON WHEELS/ MÓDULOS CON RUEDAS/ MODULES AVEC ROULETTES/ MODULE MIT ROLLEN/ MODULI CON ROTELLE

* Estantería de fondo total 35,5 sin carro sobre ruedas / 35,5-centimeter depth bookcase without trolley on casters / Étagère de profondeur totale de 35,5cm sans le chariot sur roues / Libreria con profondità 35,5 senza carrello su ruote / Total Tiefe des Regals : 35.5 ohne Wagen mit Rollen

NOTE: See containing units at page 45/ Ver módulos contenedores en pag.45/ Voir modules de rangement page 45/ Lagerungsmodule auf der Seite 45/ Vedi moduli contenitori a pagina 45.

Storage

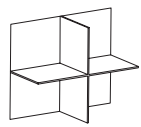

LOC100

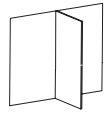

LOC110

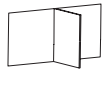

LOC200

	LENGTH	DEPTH	HEIGHT	REFERENCE
	42,7	19,1	35 cm	LOC100
	16,81"	7,52"	13,94"	
	42,7 cm	18,9 cm	35,5 cm	LOC110
	16,81"	7,44"	13,98"	
	42,7 cm	18,9 cm	20,6 cm	LOC200
	16,81"	7,44"	8,11"	

SIDEBORD

WOODEN SHELF WITH METAL FRAME AND BACK PANEL.

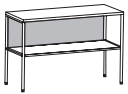

120,3	35,5	76, cm	LPS101
47,36"	13,98"	29,92"	

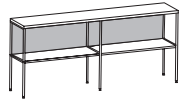

179	35,5	76, cm	LPS102
70,47"	13,98"	29,92"	

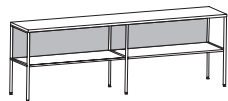

239	35,5	76, cm	LPS103
94,09"	13,98"	29,92"	

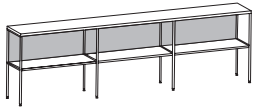

267	35,5	76, cm	LPS104
105,12"	13,98"	29,92"	

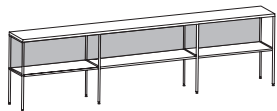

297	35,5	76, cm	LPS105
116,93"	13,98"	29,92"	

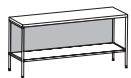

120,3	35,5	53,5 cm	LPS001
47,36"	13,98"	21,65"	

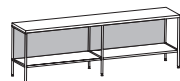

179	35,5	53,5 cm	LPS002
70,47"	13,98"	21,65"	

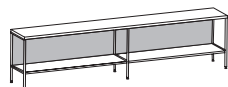

239	35,5	53,5 cm	LPS003
94,09"	13,98"	21,65"	

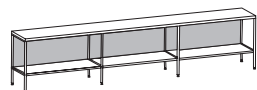

267	35,5	53,5 cm	LPS004
105,12"	13,98"	21,65"	

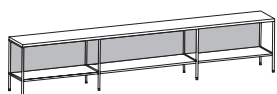

297	35,5	53,5 cm	LPS005
116,93"	13,98"	21,65"	

BACK PANEL

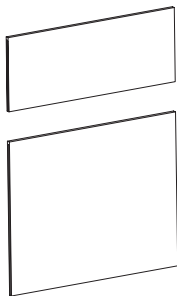

LENGTH	DEPTH	HEIGHT	REFERENCE
87	34,5	1,6 cm	LPS62G
34,25"	13,58"	,63"	
117	34,5	1,6 cm	LPS63G
46,06"	13,58"	,63"	
87	70,8	1,6 cm	LPS64G
34,25"	27,87"	,63"	
117	70,8	1,6 cm	LPS65G
46,06"	27,87"	,63"	

SIDE PANEL

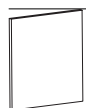

32	34,5	1,6 cm	LPS50G
12,6"	13,58"	,63"	

87cm- 13,86": STORAGE MODULES/ MÓDULOS CONTENEDORES/ MODULES CONTENEURS/ LAGERUNGSMODULE/ MODULI DI ARCHIVIAZIONE

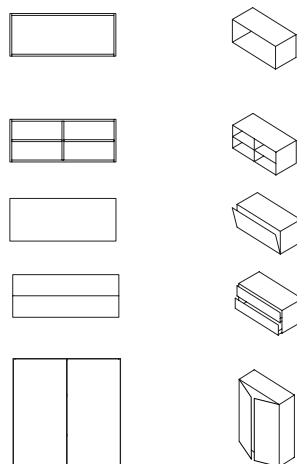

87	35,2	34,7 cm	LOB201
34,25"	13,86"	13,66"	
87	35,2	34,7 cm	LOB203
34,25"	13,86"	13,66"	
87	35,2	34,7 cm	LOB204
34,25"	13,86"	13,66"	
87	35,2	34,7 cm	LOB210
34,25"	13,86"	13,66"	
87	35,2	107, cm	LOB501
34,25"	13,86"	42,13"	

117 cm - 46,06": STORAGE MODULES/ MÓDULOS CONTENEDORES/ MODULES CONTENEURS/ LAGERUNGSMODULE/ MODULI DI ARCHIVIAZIONE

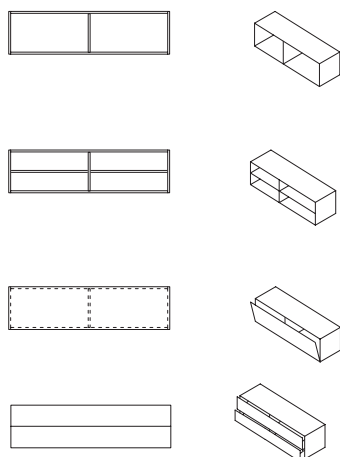

117	35,2	34,7 cm	LOB301
46,06"	13,86"	13,66"	
117	35,2	34,7 cm	LOB313
46,06"	13,86"	13,66"	
117	35,2	34,7 cm	LOB304
46,06"	13,86"	13,66"	
117	35,2	34,7 cm	LOB310
46,06"	13,86"	13,66"	