

# Dining Tables | oval

Oak

standard



chamfered



Butterfly

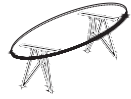

Co



Legno (oak)



New Classic

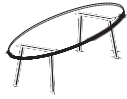

New Co



Slim Co



Slim X-type



Topple



Length (cm)	Width (cm)	Thickness (cm)	Height (cm)
200	120	3	74
220	120	3	74
240	120	3	74
260	120	3	74
280	120	3	74
300	120	3	74
200	120	4	75
220	120	4	75
240	120	4	75
260	120	4	75
280	120	4	75
300	120	4	75
350	150	4	75
400	150	4	75

200 - 400 | 78 3/4" - 157 1/2"



120 - 150 | 47 1/4" - 59"

200 - 400 | 78 3/4" - 157 1/2"



74 - 75 | 29 1/4" - 29 1/2"

120 - 150 | 47 1/4" - 59"



3 - 4 | 11 1/4" - 11 1/2"

71 | 28"

Tabletop

Oak

Frame

Steel

Oak

# Dining Tables | oval

Walnut

standard



chamfered



Butterfly

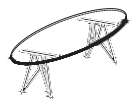

Co



New Classic



New Co

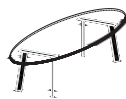

Slim Co



Slim X-type



Topple



Length (cm)	Width (cm)	Thickness (cm)	Height (cm)
200	120	3	74
220	120	3	74
240	120	3	74
260	120	3	74
280	120	3	74
300	120	3	74
200	120	4	75
220	120	4	75
240	120	4	75
260	120	4	75
280	120	4	75
300	120	4	75
350	150	4	75
400	150	4	75

200 - 400 | 78 3/4" - 157 1/2"



120 - 150 | 47 1/4" - 59"

200 - 400 | 78 3/4" - 157 1/2"



75 | 29 1/4" - 29 1/2"

120 - 150 | 47 1/4" - 59"



3 - 4 | 11 1/4" - 11 1/2"

71 | 28"

Tabletop

Walnut

Frame

Steel

# Dining Tables | oval

HPL Fenix

standard



chamfered



Butterfly



Co



Legno (oak)



New Classic

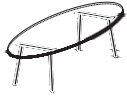

New Co



Slim Co



Slim X-type



Topple



Length (cm)	Width (cm)	Thickness (cm)	Height (cm)
200	120	4	75
220	120	4	75
240	120	4	75
260	120	4	75
280	120	4	75
300	120	4	75
350	150	4	75
400	150	4	75

200 - 400 | 78 3/4" - 157 1/2"



120 - 150 | 47 1/4" - 59"

200 - 400 | 78 3/4" - 157 1/2"



75 | 29 1/2"

120 - 150 | 47 1/4" - 59"



71 | 28"

Tabletop

HPL Fenix | see all finish options on page 110

Frame

Steel | see all finish options on page 111

Oak | see all finish options on page 109

# Dining Tables High | oval

Oak



Butterfly 92 or 105



Co 92 or 105



Legno (oak) 92 or 105



New Classic 92 or 105



New Co 92 or 105



Slim X-type 92 or 105



Length (cm)	Width (cm)	Thickness (cm)	Height (cm)
200	120	4	92/105
220	120	4	92/105
240	120	4	92/105
260	120	4	92/105
280	120	4	92/105
300	120	4	92/105

92 Height (cm)

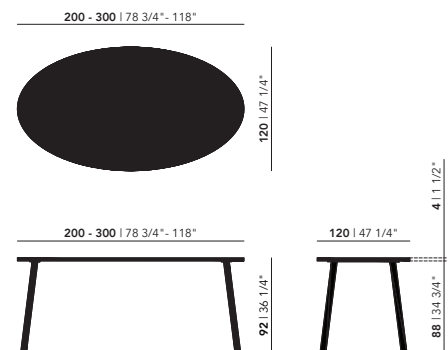

105 Height (cm)

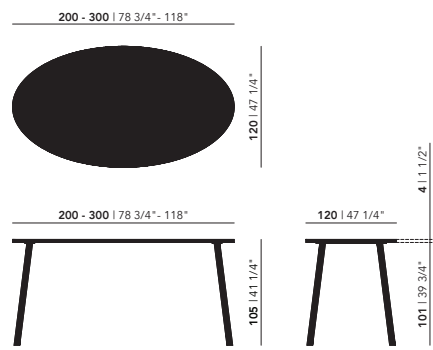

Tabletop

Oak

Frame

Steel

Oak

# Dining Tables High | oval

Walnut

standard

chamfered



Butterfly 92 or 105



Co 92 or 105



New Classic 92 or 105



New Co 92 or 105



Slim X-type 92 or 105



Length (cm)	Width (cm)	Thickness (cm)	Height (cm)
200	120	4	92/105
220	120	4	92/105
240	120	4	92/105
260	120	4	92/105
280	120	4	92/105
300	120	4	92/105

92 Height (cm)

200 - 300 | 78 3/4" - 118"



120 | 47 1/4"

105 Height (cm)

200 - 300 | 78 3/4" - 118"



120 | 47 1/4"

200 - 300 | 78 3/4" - 118"



92 | 36 1/4"

120 | 47 1/4"

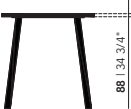

4 | 1 1/2"

88 | 34 3/4"

200 - 300 | 78 3/4" - 118"



105 | 41 1/4"

120 | 47 1/4"

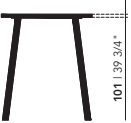

4 | 1 1/2"

101 | 39 3/4"

Tabletop

Walnut

Frame

Steel

# Dining Tables High | oval

HPL Fenix

standard

chamfered



Butterfly 92 or 105



Co 92 or 105



Legno (oak) 92 or 105



New Classic 92 or 105



New Co 92 or 105



Slim X-type 92 or 105



Length (cm)	Width (cm)	Thickness (cm)	Height (cm)
200	120	4	92/105
220	120	4	92/105
240	120	4	92/105
260	120	4	92/105
280	120	4	92/105
300	120	4	92/105

92 Height (cm)

105 Height (cm)

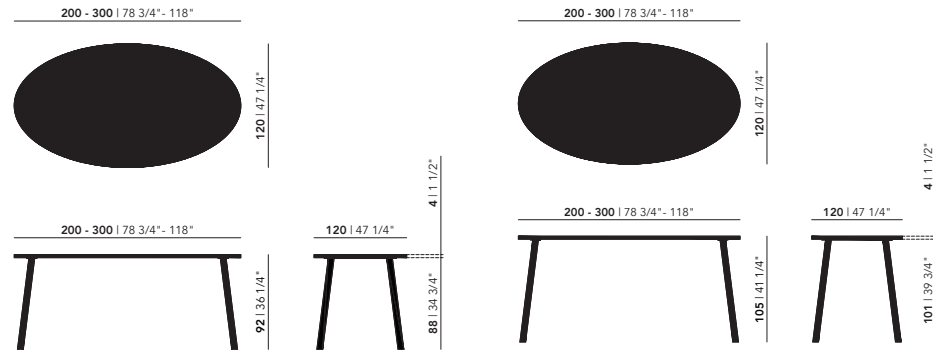

Tabletop

HPL Fenix

Frame

Steel

Oak

# Dining Tables | flat oval

Oak

standard



chamfered



Base (oak)



Butterfly



Co



Legno (oak)



New Classic



New Co



Slim Co



Slim X-type



Topple



200 - 400 | 78 3/4" - 157 1/2"



90 - 100 | 35 1/2" - 39 1/4"

200 - 400 | 78 3/4" - 157 1/2"



74 - 75 | 29 1/4" - 29 1/2"

90 - 100 | 35 1/2" - 39 1/4"



3 - 4 | 1 1/4" - 1 1/2"

71 | 28"

Length (cm)	Width (cm)	Thickness (cm)	Height (cm)
200	90	3	74
220	90	3	74
240	90	3	74
260	90	3	74
280	90	3	74
300	90	3	74
200	100	3	74
220	100	3	74
240	100	3	74
260	100	3	74
280	100	3	74
300	100	3	74
200	90	4	75
220	90	4	75
240	90	4	75
260	90	4	75
280	90	4	75
300	90	4	75
350	90	4	75
400	90	4	75
200	100	4	75
220	100	4	75
240	100	4	75
260	100	4	75
280	100	4	75
300	100	4	75
350	100	4	75
400	100	4	75

Tabletop

Oak

Frame

Steel

Oak

# Dining Tables | flat oval

Walnut

standard



chamfered



Butterfly

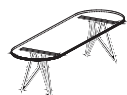

Co



New Classic



New Co



Slim Co



Slim X-type



Topple



200 - 400 | 78 3/4" - 157 1/2"



90 - 100 | 35 1/2" - 39 1/4"

200 - 400 | 78 3/4" - 157 1/2"



74 - 75 | 29 1/4" - 29 1/2"

90 - 100 | 35 1/2" - 39 1/4"



3 - 4 | 1 1/4" - 1 1/2"

71 | 28"

Length (cm)	Width (cm)	Thickness (cm)	Height (cm)
200	90	3	74
220	90	3	74
240	90	3	74
260	90	3	74
280	90	3	74
300	90	3	74
200	100	3	74
220	100	3	74
240	100	3	74
260	100	3	74
280	100	3	74
300	100	3	74
200	90	4	75
220	90	4	75
240	90	4	75
260	90	4	75
280	90	4	75
300	90	4	75
350	90	4	75
400	90	4	75
200	100	4	75
220	100	4	75
240	100	4	75
260	100	4	75
280	100	4	75
300	100	4	75
350	100	4	75
400	100	4	75

Tabletop

Walnut

Frame

Steel



# Dining Tables | flat oval

HPL Fenix

standard



chamfered



Base (oak)



Butterfly

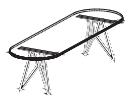

Co



Legno (oak)



New Classic



New Co



Slim Co



Slim X-type



Topple



Length (cm)	Width (cm)	Thickness (cm)	Height (cm)
200	90	4	75
220	90	4	75
240	90	4	75
260	90	4	75
280	90	4	75
300	90	4	75
350	90	4	75
400	90	4	75
200	100	4	75
220	100	4	75
240	100	4	75
260	100	4	75
280	100	4	75
300	100	4	75
350	100	4	75
400	100	4	75

200 - 400 | 78 3/4" - 157 1/2"



90 - 100 | 35 1/2" - 39 1/4"

200 - 400 | 78 3/4" - 157 1/2"



75 | 29 1/2"

90 - 100 | 35 1/2" - 39 1/4"



4 | 1 1/2"

71 | 28"

Tabletop

HPL Fenix

Frame

Steel

Oak

# Dining Tables High | flat oval

Oak



Butterfly 92 or 105



Co 92 or 105



Legno (oak) 92 or 105



New Classic 92 or 105



New Co 92 or 105



Slim X-type 92 or 105



Length (cm)	Width (cm)	Thickness (cm)	Height (cm)
200	90	4	92/105
220	90	4	92/105
240	90	4	92/105
260	90	4	92/105
280	90	4	92/105
300	90	4	92/105
200	100	4	92/105
220	100	4	92/105
240	100	4	92/105
260	100	4	92/105
280	100	4	92/105
300	100	4	92/105

92 Height (cm)

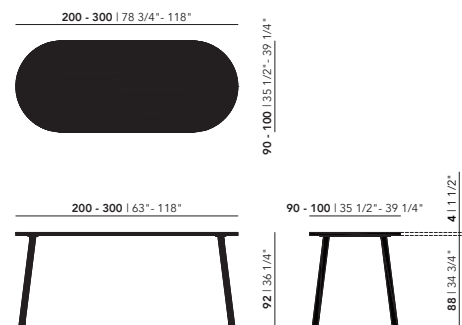

105 Height (cm)

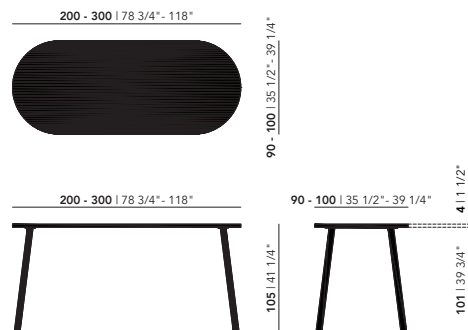

Tabletop

Oak

Frame

Steel

Oak

# Dining Tables High | flat oval

Walnut

standard

chamfered



Butterfly 92 or 105



Co 92 or 105



New Classic 92 or 105



New Co 92 or 105



Slim X-type 92 or 105



Length (cm)	Width (cm)	Thickness (cm)	Height (cm)
200	90	4	92/105
220	90	4	92/105
240	90	4	92/105
260	90	4	92/105
280	90	4	92/105
300	90	4	92/105
200	100	4	92/105
220	100	4	92/105
240	100	4	92/105
260	100	4	92/105
280	100	4	92/105
300	100	4	92/105

92 Height (cm)

105 Height (cm)

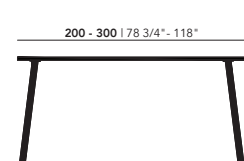
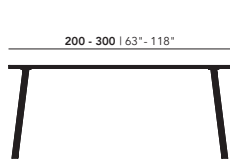
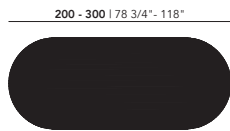

90 - 100 | 35 1/2\"/>

90 - 100 | 35 1/2\"/>

92 | 36 1/4\"/>

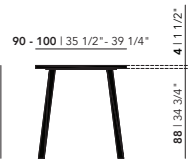

41 | 1 1/2\"/>

105 | 41 1/4\"/>



101 | 39 3/4\"/>

Tabletop

Walnut

Frame

Steel

# Dining Tables High | flat oval

HPL Fenix

standard

chamfered



Butterfly 92 or 105



Co 92 or 105



Legno (oak) 92 or 105



New Classic 92 or 105



New Co 92 or 105



Slim X-type 92 or 105



Length (cm)	Width (cm)	Thickness (cm)	Height (cm)
200	90	4	92/105
220	90	4	92/105
240	90	4	92/105
260	90	4	92/105
280	90	4	92/105
300	90	4	92/105
200	100	4	92/105
220	100	4	92/105
240	100	4	92/105
260	100	4	92/105
280	100	4	92/105
300	100	4	92/105

92 Height (cm)

105 Height (cm)

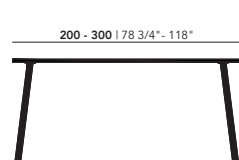
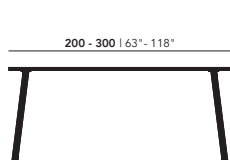

Tabletop  
HPL Fenix

Frame  
Steel  
Oak

# Finish Options

## Wood | finish options

Oak hardwax oil natural light 3041



A natural treatment with a very light whitewash. This prevents yellowing in the long term. Hardwax oil is, in contrast to lacquer, less scratch-sensitive and protects against stains.

Oak hardwax oil natural 3062



A natural treatment. This treatment is somewhat warmer or yellow-toned than the hardwax oil natural light 3041. Hardwax oil is, in contrast to lacquer, less scratch-sensitive and protects against stains.

Oak black stain



A stain finish with a black look. The stain is covered with a clear two-component lacquer. Lacquer is more sensitive to scratches than hardwax oil. This lacquer protects well against stains.

Oak smoked stain



A stain finish with a smoked look. The stain is covered with a clear two-component lacquer. Lacquer is more sensitive to scratches than hardwax oil. This lacquer protects well against stains.

Oak black lacquer



A two-component lacquer finish with the colour RAL 9016. Lacquer is more sensitive to scratches than hardwax oil. This lacquer protects well against stains. This finish is not recommended for dining tables.

Oak white lacquer



A two-component lacquer finish with the colour RAL 9016. Lacquer is more sensitive to scratches than hardwax oil. This lacquer protects well against stains. This finish is not recommended for dining tables.

Walnut natural lacquer

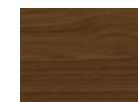

A two-component lacquer finish with a natural look. Lacquer is more sensitive to scratches than hardwax oil. This lacquer protects well against stains.

## Steel | finish options



Powdercoating | black RAL 9005

Powdercoating is a hard finish, tougher than conventional paint.



Powdercoating | white RAL 9016

Powdercoating is a hard finish, tougher than conventional paint.



Chrome

Available on request.

## HPL Fenix | finish options

A very solid plate consisting of several layers of compressed wood fiber. Fenix NTM's nanotechnology creates a very matt and silky smooth surface. It is resistant to rubbing, and minor scratching and wear. Available for tabletops and dining benches in Studio HENK's selection of colours.

Fenix NTM | 0029 Bianco Malè

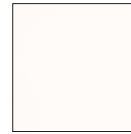

Fenix NTM | 0030 Bianco Alaska



Fenix NTM | 0032 Bianco Kos

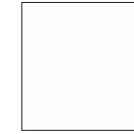

Fenix NTM | 0719 Beige Luxor



Fenix NTM | 0717 Castoro Ottawa



Fenix NTM | 0718 Grigio Londra



Fenix NTM | 0724 Grigio Bromo



Fenix NTM | 0725 Grigio Efeso



Fenix NTM | 0748 Beige Arizona



Fenix NTM | 0749 Cacao Orinoco



Fenix NTM | 0750 Verde Comodoro

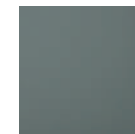

Fenix NTM | 0751 Rosso Jaipur

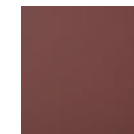

Fenix NTM | 0752 Grigio Antrim



Fenix NTM | 0754 Blu Fes

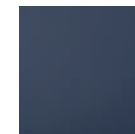

Fenix NTM | 0720 Nero Ingo

