

DIMENSIONS

Different measures available for the height of the table:

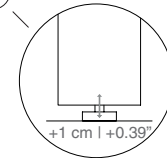
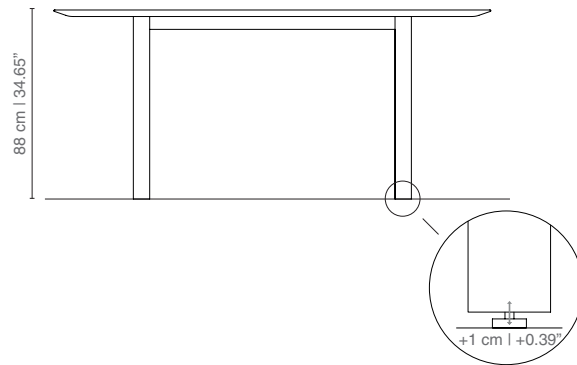
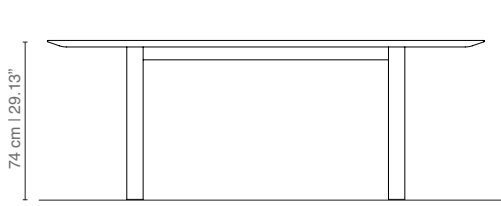

LEGS ADJUSTABLE HEIGHT

Different measures available for the width of the table top:

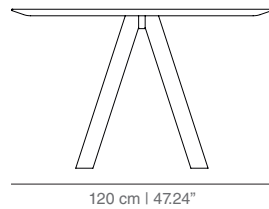
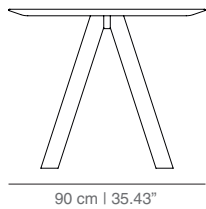

Thickness and type of table top edge:

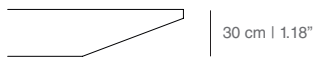
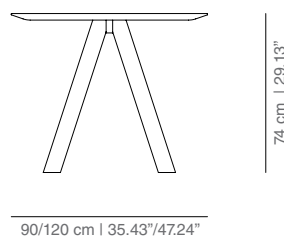
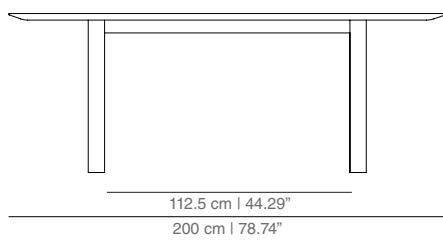
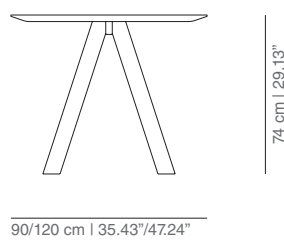
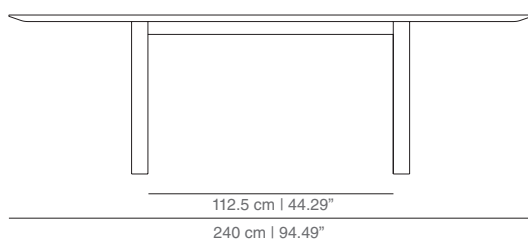

TABLE HEIGHT 74

TRMSC simple table 200 width 90
TRMSC_A simple table 200 width 120



TRMS simple table 240 width 90
TRMSA simple table 240 width 120



TRMD double table width 90
TRMD_A double table width 120

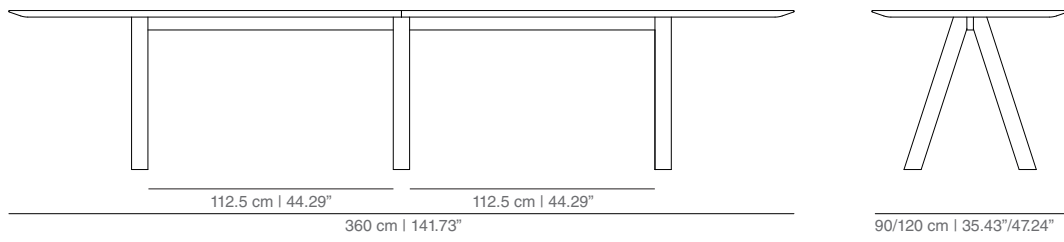

TRMT triple table width 90
TRMT_A triple table width 120

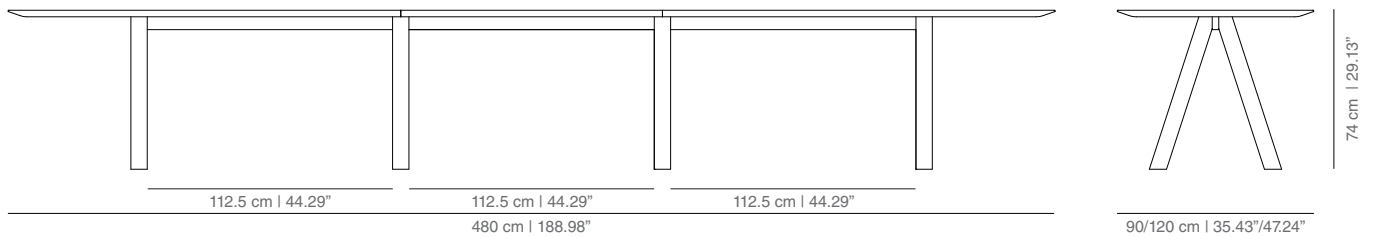
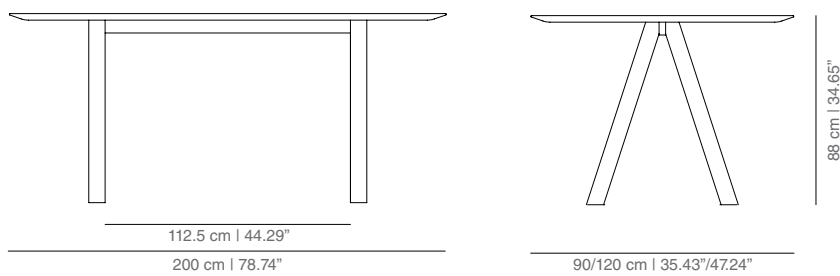
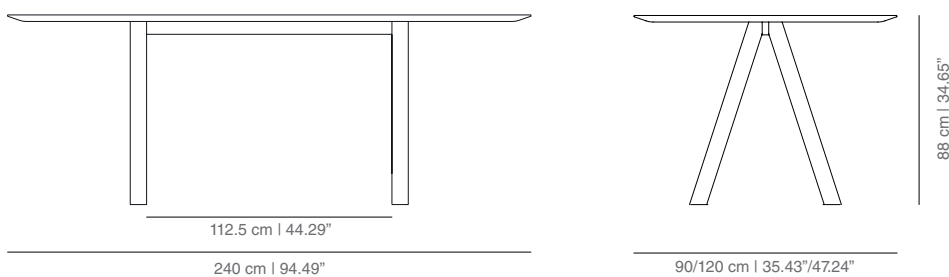

TABLE HEIGHT 88

TRMSC_H simple table 200 width 90
TRSMC_AH simple table 200 width 120



TRMS_H simple table 240 width 90
TRMS_AH simple table 240 width 120



TRMD_H double table width 90
 TRMD_AH double table width 120

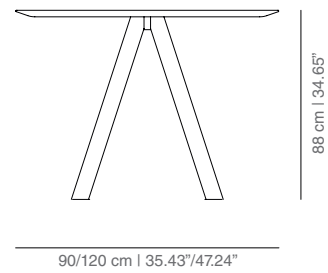
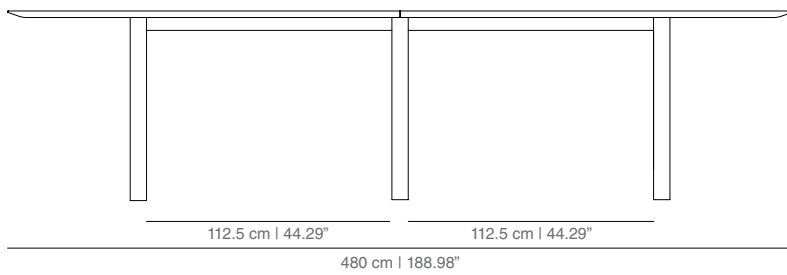

TRMT_H triple table width 90
 TRMT_AH triple table width 120

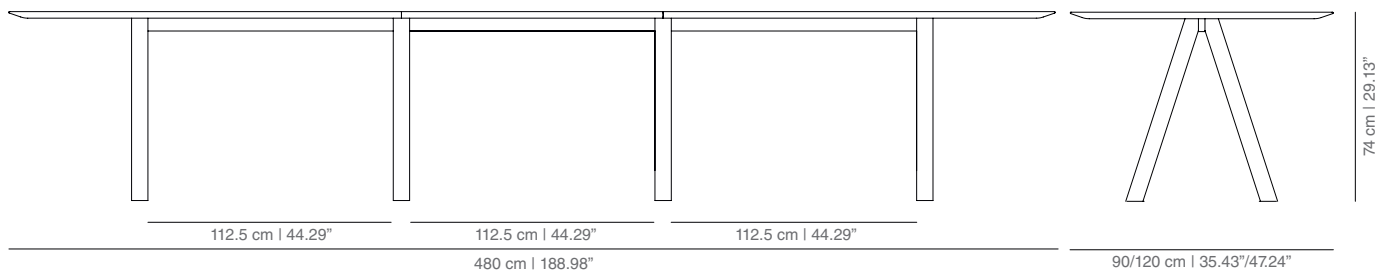

ACCESSORIES

AC03B conduit

Cut out of the table top is included.

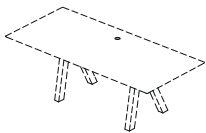

TRMEC cut out

Table top with incision to measure.

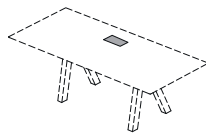

CAP rectangular conduit

Metallic access placket to the lower part of the table. Available in white, black or grey. Does not include electrifications.



CAPP rectangular conduit plus

Metal access placket to the lower part of the table, for wooden table tops. Metal frame available in black or grey and central part in the veneer of the finish of the table. Does not include electrifications.

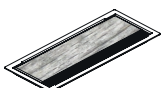

BOX power box for tabletop

Metal placket with 4 plugs or combined with integrated multimedia elements. Available in white, black or grey.

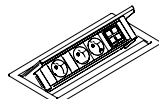

BOXP power box plus for tabletop

Metal placket with 4 plugs or combined with integrated multimedia elements, for wooden table tops. Metal frame available in black or grey and central part in the veneer of the finish of the table.

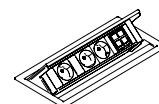

PROT table top protector in eco leather

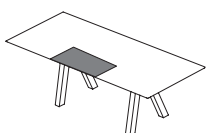

COMPONENTS FOR COMPOSITIONS OF TABLES

For different compositions to those suggested, is offered the possibility to create your own compositions. For all of them will have to choose two end table tops, central table tops according to the length of the table, and the legs (the number of legs will be the result of the number of total table tops plus 1).

TRPM legs height 74

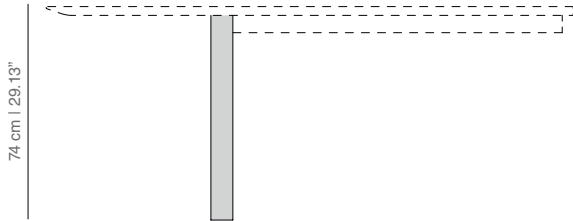

TRPMH legs height 88

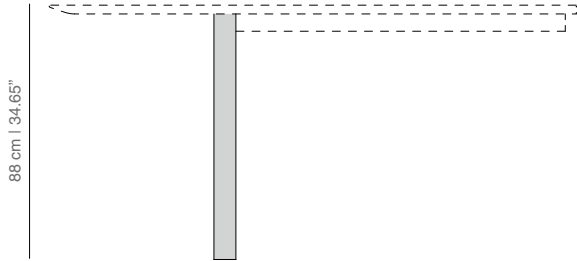

TRME end table top L180 width 90
TRMEA end table top L180 width 120

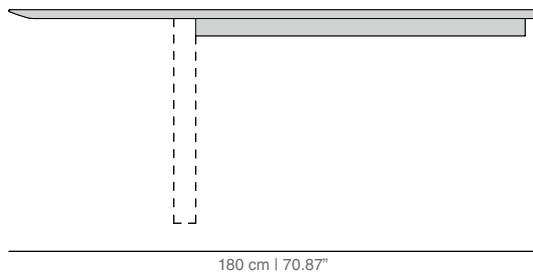

TRMC end table top L120 width 90
TRMCA end table top L120 width 90

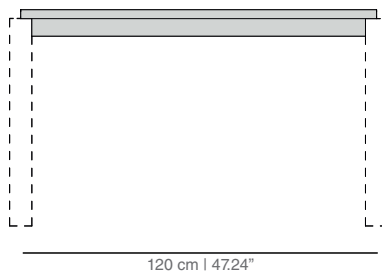

SUGGESTIONS

HOME

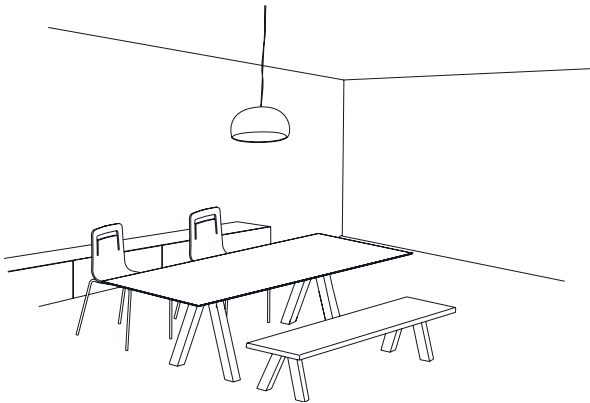

OFFICE

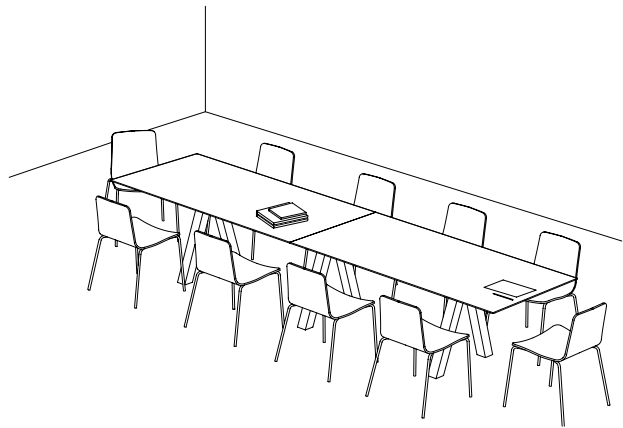
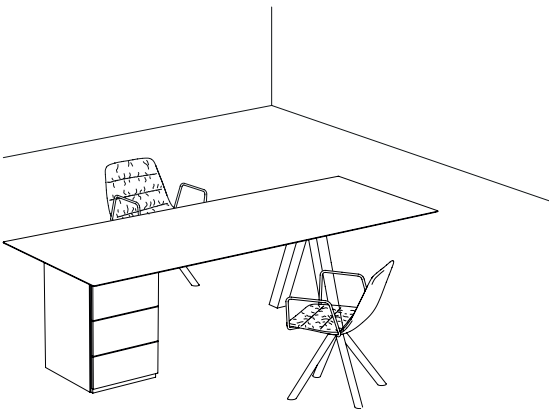

RESTAURANT

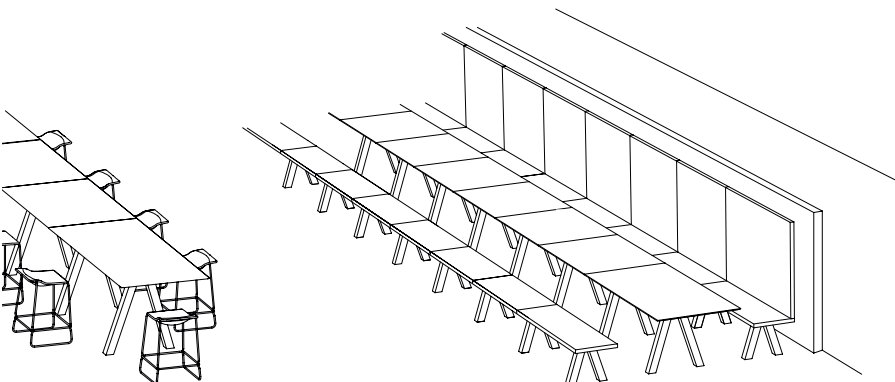

TECHNICAL INFO

The elegance of Pawson surprises us once again with this immense table and bench of exquisite proportions, for tables 74 cm height and 88 cm counter height.

The table top is available in two different finishes and width (90 cm and 120 cm):

- 30 mm MDF board with a natural oak veneer stained in matt, cognac, ash or wenge. Micro-textured lacquer in white, black, grey, sand or smoke also available.
- High pressure HPL laminate in white or black on a 30 mm thick MDF board with stained edges.

Stained solid oak or solid beech legs lacquered with the finishes from our collection.

FINISHES

TABLE TOP

Lacquered



White
RAL 9003



Black
RAL 9005



Grey
RAL 7007



Sand
NCS 3005Y50R



Smoke grey
RAL 1019

HPL with MDF



White
RAL 9003



Black
RAL 9005

Stained (Oak Veneer)



Matt
oak



Wenge



Cognac



Ash

LEGS

Lacquered (Beech)



White
RAL 9003



Black
RAL 9005



Grey
RAL 7007



Sand
NCS 3005Y50R



Smoke grey
RAL 1019

Stained (Oak)



Matt
oak



Wenge



Cognac



Ash

CERTIFICATE

UNE EN 527-1:11
UNE EN 527-2-3:03
ANSI - BIFMA X5.5:2014

